

84R FAÇADE

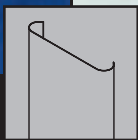

www.luxalon.com

LUXALON®

Façade Systems

A HunterDouglas® PRODUCT

Short system description

The Luxalon® 84R Façade System consists of 84 mm wide rollformed, round edged panels (1), which can simply be clicked on the prongs of a 84R stringer (3) to form horizontal or vertical lines. The stove enamelled aluminium panels are recyclable, lightweight and strong. The panels are made to measure and can be supplied in any length from 800 up to 6000 mm (other lengths are available on request). Panels can be joined by using the panel splice (5) or by means of panel overlap. Between the panels there is an open joint. Depending on the type of stringer used, these joints can be filled with a reversed panel or join profile (2a, 2b) to form a closed façade appearance. The join profiles or reversed panels can be simply inserted or slide into the open joint by hand, without using any tools. The stringer (3) is black, made of 0.95 mm thick stove enamelled aluminium and is provided with prongs to accommodate the panels. Different modules are available (see system overview). Stringers have a standard length of 5000 mm.

Practical applications

- Between the panels there is an open joint, which can be closed with reversed panels or join profiles. The panels combined with these provide a visually closed façade.
- Open joint systems can be created for all applications requiring open area for ventilation, acoustics etc.
- Curved façades can be achieved by using curved 84R panels.
- The façades have a concealed fixing system.
- Panel length made to measure from 800 up to 6000 mm, allowing for swift installation and reducing the need for joining the panels to a minimum.
- Panels are made from a corrosion resistant aluminium alloy.
- The Luxacote® coating combined with aluminium of the highest category for corrosion resistance, guarantees:
 - Colour and gloss stability;
 - High scratch resistance;
 - High corrosion resistance.

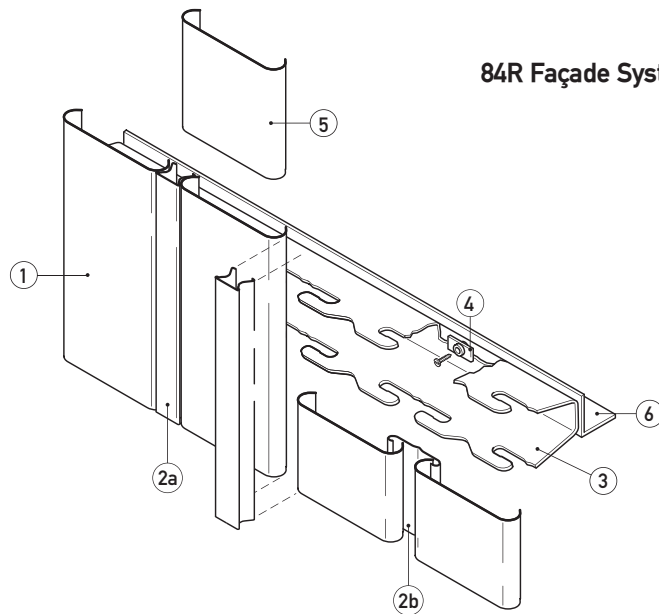

84R Façade System Overview

1 = 84R panel	4 = washer set
2a = flush join profile	5 = panel splice
2b = recessed join profile	6 = non Luxalon® sub-construction
3 = 84R stringer	

Note: 84R panels can be installed horizontally as well as vertically or diagonally depending on desired directional emphasis. Curved panels are available.

- Facades are based on a ventilating principle providing optimum control for building physics.
- Can be combined with Luxalon® 84R Sun Louvre system in order to obtain a very open facade.



Dimensions, weight & material requirements

Stringer type	V-2	V-3	V-4	V-5	V-6	V-8	H3
Module	146	157.7	90	100	111	166.6	69
Material per m ²							
Panels (lm)	6.85	6.34	11.11	10	9	12	14.49
Reversed panels (lm)	6.85	6.34	-	-	-	-	-
Join profile (lm)	-	-	-	10	9	12	-
Stringers	1.6	1.6	1.6	1.6	1.6	1.6	1.6
Washer sets/screws	4.7	4.7	4.7	4.7	4.7	4.7	4.7
Weight kg/m ²							
Excl. joint or reversed panels	1.44	1.35	2.2	2	1.8	2.58	2.9
Incl. joints or reversed panels	2.7	2.5	-	2.5	2.2	2.98	-

The required number of components depends on individual project requirements. Figures are based on a façade installed on 3 or more stringers and submitted to a wind-load of 1500 N/m².

Standard construction details

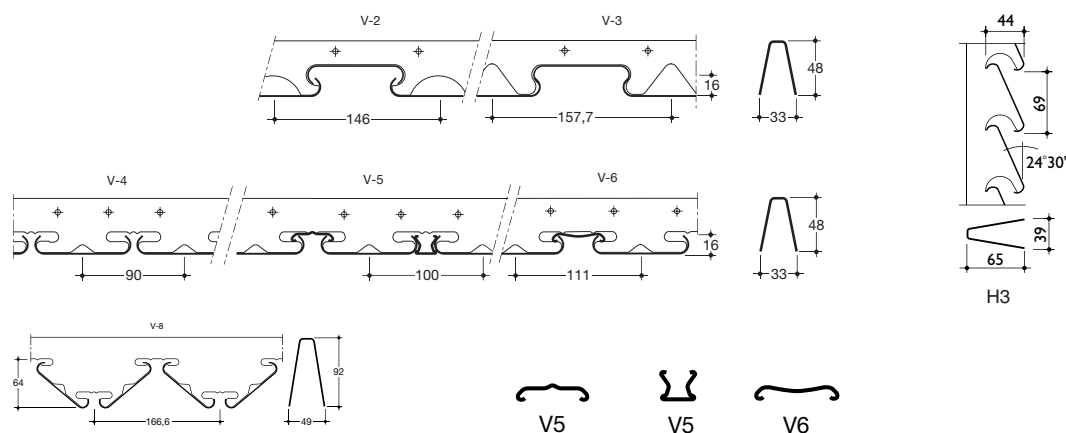

Maximum spans

- Stringer span (B)

Before establishing the fixing distance of the stringers, the load per linear meter stringer is to be determined by the formula in the following table.

Panels installed on:	Calculation of 'load per linear meter stringer'
2 stringers	$0.5 \times q \times l$
3 stringers	$1.25 \times q \times l$
4 or more stringer	$1.15 \times q \times l$

q = windload in N/m^2 (uniformly distributed loads)
 l = panelspan (c) in m

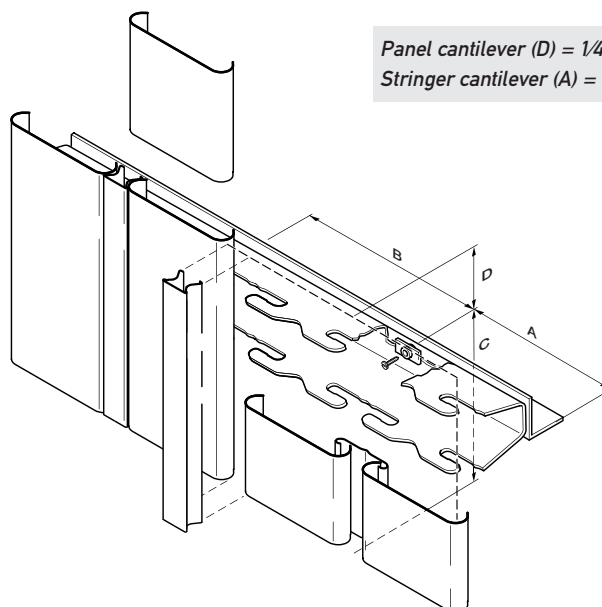

The stringer span (screw distance) (B) can be read from the graph in the same way as the panel span.

Following the example:

$$Q = 1,15 \times 1500 \times 0,625 = 1078 \text{ N/m}$$

Giving a fixing distance of 0.34 m.

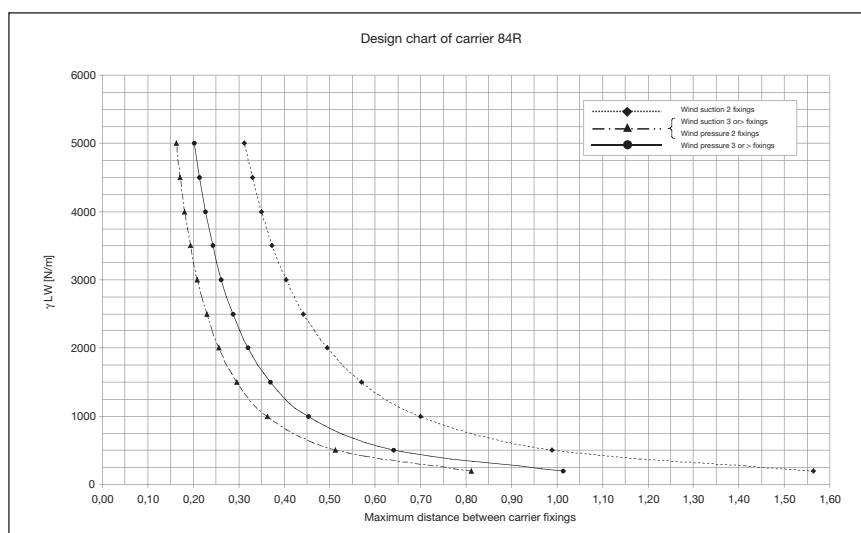

- Panel span (C)

The panel spans, in relation to the wind load (pressure or suction), can be calculated from the graph.

At 1500 N/m^2 the maximum panel span for 84R is 0.625 m on 3 or more stringers (windsuction).

* Panel span max. 0.8 m when using flush join profiles.

Note: Wind pressure/suction shall be determined with due consideration to the relevant local country's Standard Codes of Building Practice.

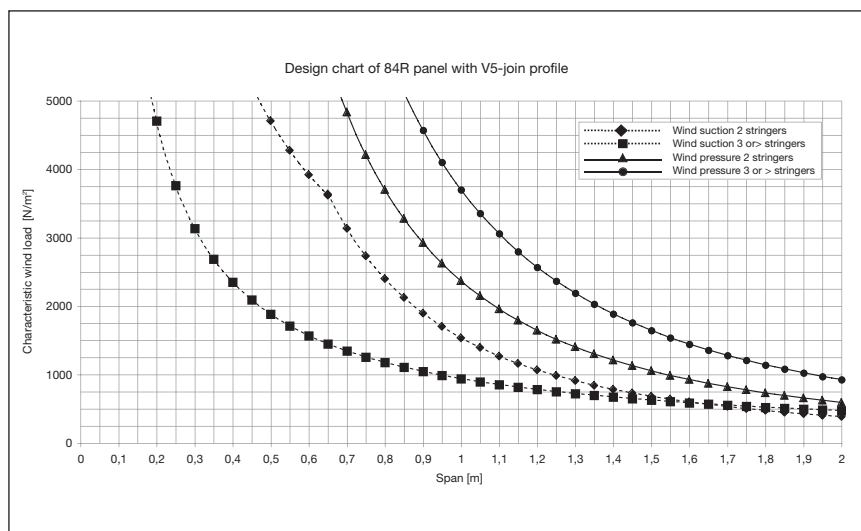



Luxalon® 84R Curved panels

OUTSIDE CORNER

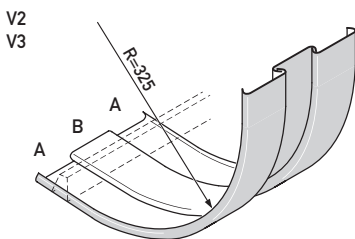

INSIDE CORNER

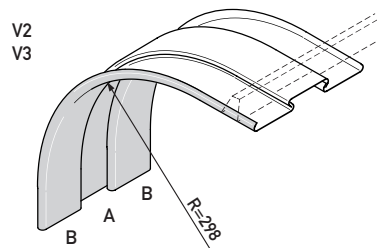

The Luxalon® 84R Façade System allows architects to build curves into their designs, creating soft, undulating shapes, re-entrant curves and bulkheads. Any angle up to 90° with either a fixed radius of approximately 320 mm or a variable radius with a minimum of 1000 mm can be specified. Optionally corner pieces in lengths up to 6000 mm can be supplied.

OUTSIDE CORNER

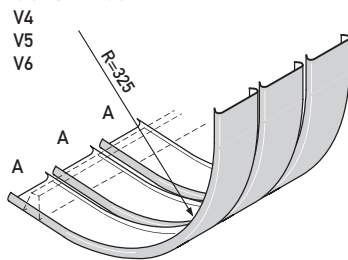

INSIDE CORNER

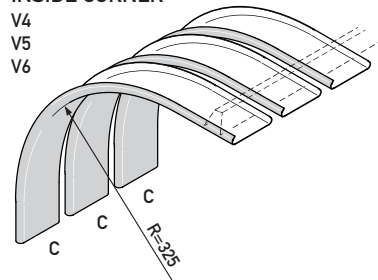

The curved panels for exterior façades and ceilings can be used with the stringer types V2 to V6. The recessed join profile for stringer type V5 is also available with the same curvatures. Ceiling to wall junctions can now be rounded with beams and other projections being smoothed out. Panelling can be continued from the ceiling, to the façade or partly clad the wall, with an imperceptible joint between horizontal and vertical panels.

Panel length calculation

Depending on the type of corner and the corner angle required, the drawings and formula below will give you information to calculate the developed panel length (L). C and D represent the length of the straight panel beyond the corner, and the angle required.

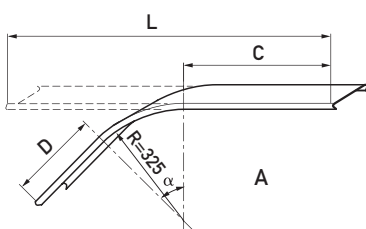

$$L = C + D + (\alpha \times 5.62)$$

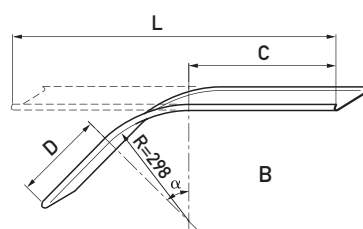

$$L = C + D + (\alpha \times 5.25)$$

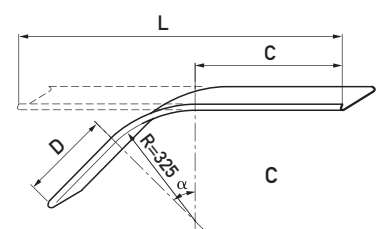

$$L = C + D + (\alpha \times 5.72)$$

Luxalon® 84R Façade System

- Horizontal or vertical panels
- Simple, flexible design
- Concealed, versatile fixing system
- Wide colour range
- Panels available in curved format up to 90°
- Light-weight aluminium components
- Luxacote® finish for colour fastness, corrosion resistance
- Suitable for exterior ceilings
- Extends creative freedom
- Open or closed by means of reversed panels or join profiles

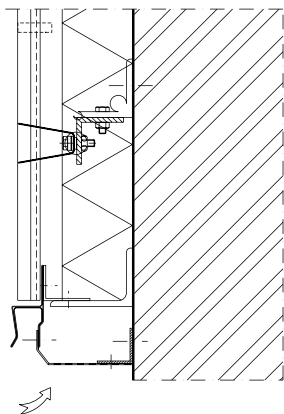
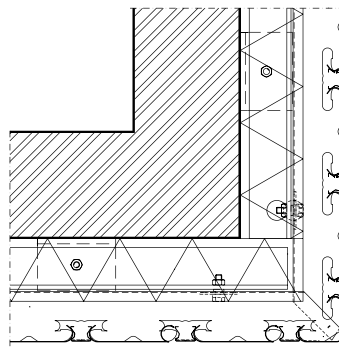
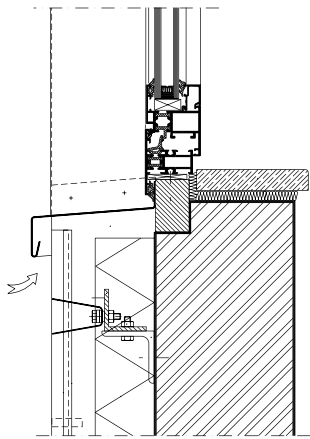
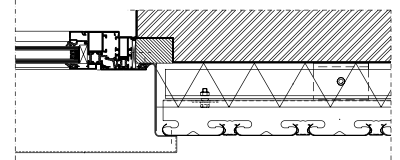
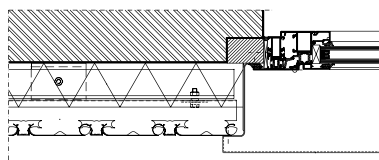
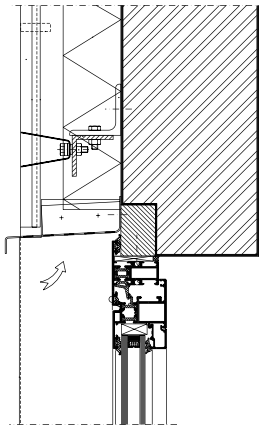
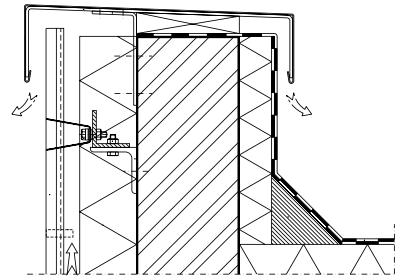

A wide range of system solutions is available on CD-rom.

Luxalon® 84R Façade System

Part 1. 84R Façade System general

- 1.1 Introduction
Supply and fix Luxalon® 84R Façade System as manufactured by Hunter Douglas Architectural Products.
- 1.2 Description of the system
The system will consist of linear rollformed aluminium panels with round edges, which can simply be clicked on the prongs of a stringer. The stringers are fixed on a non-Luxalon® sub-construction. To prevent contact corrosion by applying dissimilar metals, each fixing of the stringers to the sub-construction must be made through the Luxalon® washer set.

Part 2. Product

_____ m² Luxalon® 84R Façade System consisting of:

- 2.1 Panels
84R: size 84 x 16 mm manufactured from 0.6 mm aluminium. Panels to be manufactured from pre-painted, stove enamelled aluminium, corrosion resistant alloy EN-AW-3005 or equivalent (according to EN 1396 and EN 13523). Panels have a length of _____ mm (manufacturer availability 800-6000 mm, other lengths on request). Panels to be coupled in longitudinal direction by means of panel splices or by means of panel overlap.

Curved panels with a radius of _____ mm.
Panels have a length of _____ mm.

- 2.2 Join Profiles
Flush join profiles, width 16 mm, manufactured from 0.35 mm aluminium
Recessed join profiles, width 16 mm, manufactured from 0.65 mm aluminium
Recessed join profiles, width 27 mm, manufactured from 0.65 mm aluminium

Join profiles to be manufactured from pre-painted, stove enamelled aluminium, corrosion resistant alloy EN-AW-3005 or equivalent (according to EN 1396 and ECCA). Join profiles have a standard length of 5000 mm. Join profiles to be coupled in longitudinal direction by means of butting them together.

- 2.3 Stringers
Rows of 0.95 mm thick aluminium rollformed stringers shall be installed at _____ centre to centre on a sub-construction consisting of a supporting steel or aluminium framing of sufficient strength and rigidity to provide resistance to wind-pressure/suction. Stringers are provided with prongs to hold panels in a module of 146 mm (V2) or 157.7 mm (V3) or 90 mm (V4) or 100 mm (V5) or 111 mm (V6) or 116.6 mm (V8).

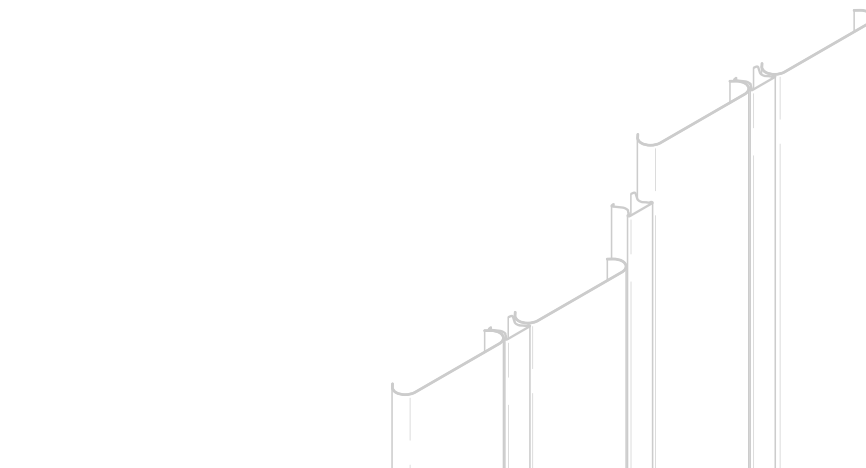

Part 3. Additional specification

3.1 Profiles
Edge, trims drip sections, capping etc. made of stove enamelled aluminium strip, with Luxacote® paint finish (± 30 micron).

3.2 Coating
Architect will make a colour selection from the standard Hunter Douglas colour range for Luxalon® exterior 84R panels code no. _____ or a special colour will be made to match.

3.3 Installation
All materials shall be installed in strict compliance with all local codes, ordinances and manufacturers recommendations including specific additional requirements as may be called for in the specifications or shown on the drawings.

LUXALON®



Material specifications

- Base material

The Luxalon® 84R panels are rollformed from 0.6 mm thick pre-painted stove enamelled aluminium strip. In order to reach the optimal durability level, Hunter Douglas utilises highly corrosion resistant alloy types as EN-AW-3005 or equivalent. All aluminium products can be recycled for the full 100% requiring very little energy.

- Coating

The Luxacote® patented system is applied in a coil coating process. The continuous process allows Hunter Douglas to coat aluminium coil with a 3-layered system in a very efficient way:

- The Anorcoat is the key to the excellent performance of the Luxacote® system. It is thicker and more protective than conventional conversion layers. It anchors the paint to the metal surface and protects it from corrosion.
- The Colour Coating is based on polyurethane and does not contain chlorides, fluorides or halogens. Only highly colour-stable pigments are used to assure optimal colourfastness.
- The transparent Topcoat is a fully integrated polyamide skin that gives the Luxacote® system a highly scratch and wear resistant surface. It also provides extra durability of colour and gloss.

HunterDouglas®

Hunter Douglas is the world market leader in window covering and a major manufacturer of Architectural Products. The group, which origin goes back to 1919, is comprised over 150 companies with manufacturing and assembly organizations in more than 100 countries.

HUNTER DOUGLAS EUROPE B.V.

2, Piekstraat - P.O. Box 5072 - 3008 AB Rotterdam - Tel. 010-4869911 - Fax 010-4847910 - www.luxalon.com

© Registered trademark - a HunterDouglas® product Pats. & Pats. Pend. - Technical data subject to change without notice. MX620F00
 © Copyright Hunter Douglas 2005. No rights can be derived from copy, text pertaining to illustrations or samples. Subject to changes in materials, parts, compositions, designs, versions, colours etc., even without notice.

- Colour range

The standard Luxalon® colour range for 84R Façade Systems includes different colours and finishes. Please refer to the Luxalon® exterior colour chart. Any other colour (RAL or NCS) is available on request.

Exterior ceiling application

The Luxalon® 84R Façade System can also be used as an exterior ceiling. See separate brochure for further details.



LUXALON®
F A C A D E S Y S T E M S